

"HUM KILLER" Stereo Audio Isolation Transformer - Dual RCA inputs and outputs

Removes Hum or Noise From Audio



Features:

- Ground Isolation in Unbalanced Line
- Ground-Loop Elimination
- Unbalanced Stereo Galvanic Isolation
- Isolation in Rugged Field Case
- Portable or Permanent Isolation Module



Passive, No Power Supply Required

Part # AV-HK1

Transformer Products

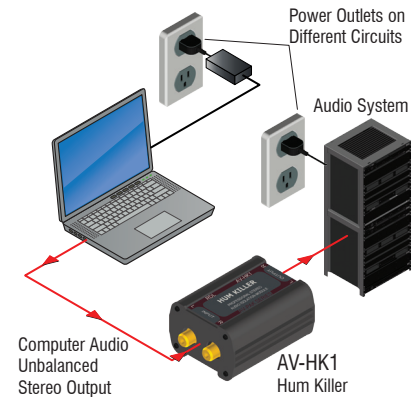

Balanced to Unbalanced Transformer - Adjustable

Converts Pro to Consumer Line Level



Features:

- Provides transformer isolation between balanced line and unbalanced input
- Level trimpot adjusts output 4 to 24 dB below input level
- Input may be 10 k Ohm bridging or 600 Ohm terminated
- Frequency response 20 Hz to 20 kHz (+/- 0.5 dB)
- THD: < 0.05% (1 kHz)



Passive, No Power Supply Required

Part # TX-1A

Transformer Products

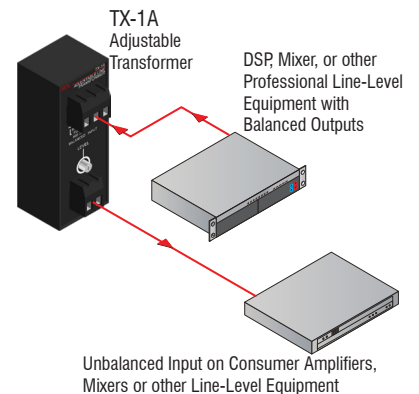

25 V, 70 V, 100 V Speaker Level Input Interface - Unbalanced line output

Converts Constant Voltage to Line Level



Features:

- Matches a 100, 70 or 25 volt speaker line to any unbalanced line-level audio input
- Trimmer adjusts output level for various input voltage/power levels
- Frequency response: 20 Hz to 20 kHz (+/- 0.5 dB)
- THD: < 0.05% (1 kHz)



Passive, No Power Supply Required

Part # TX-70A

Transformer Products

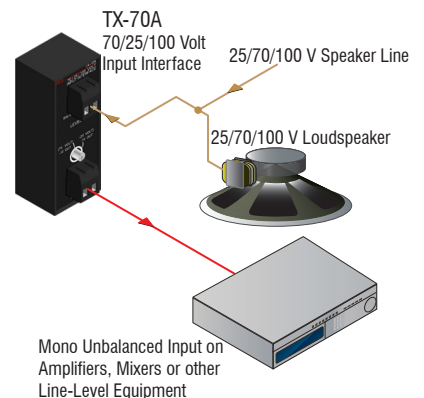

Questions?

RDL Tech Support: (928) 778-3554 | service@rdlnet.com

Product Applications & All Other Information:

www.rdlnet.com

4 Ohm / 8 Ohm Input Interface

Transformer Products

Converts 4 or 8 Ohm Speaker Level to Line Level



Features:

- Converts an Amplifier Output to Line Level
- Bridges 4 or 8 Ohm Speaker Line
- Adjustable for Wide Range of Input Power Voltage
- Converts Amplified Levels from 0.5 W to 400 W
- Suitable to Feed a Subwoofer Amplifier Input
- Detachable Terminal Block Connections
- Balanced or Unbalanced Output
- Superior Quality Audio Transformer



Passive, No Power Supply Required

Part # TX-8A

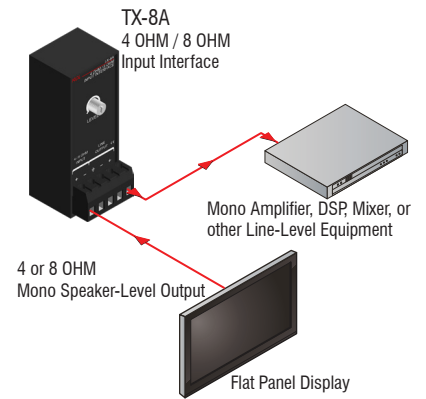

Audio Converter - Balanced to Unbalanced

Transformer Products

Converts Mono Balanced to Unbalanced



Features:

- Unbalanced Audio Outputs from a Balanced Line
- Balanced to Unbalanced Conversion
- Mono Input to Stereo Output
- +4 dBu Input Level to -10 dBV Output Level
- Studio-Quality Transformer Isolation
- Passive Converter with Output Jacks



Passive, No Power Supply Required

Part # TX-A2

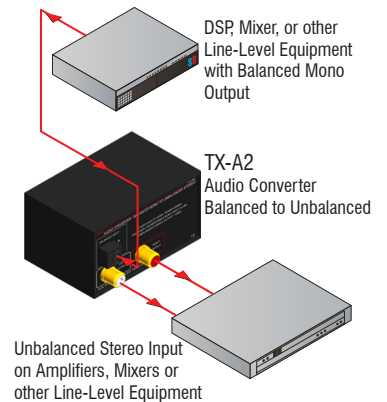

Dual Audio Converter - Balanced to Unbalanced

Transformer Products

Converts Stereo Balanced to Unbalanced



Features:

- Unbalanced Audio Outputs from a Stereo Balanced Line
- Balanced to Unbalanced Conversion
- Stereo Input to Stereo Output
- +4 dBu Input Level to -10 dBV Output Level
- Studio-Quality Transformer Isolation
- Passive Converter with Output Jacks



Passive, No Power Supply Required

Part # TX-A2D

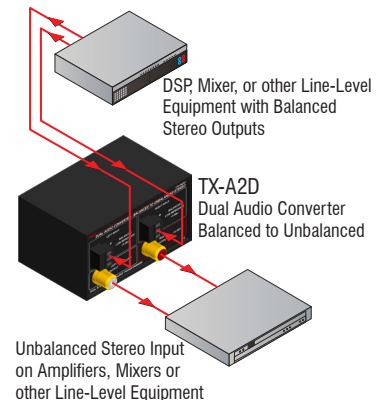

Unbalanced Input Transformer - Unbalanced stereo inputs to summed balanced mono output

Transformer Products

Converts Stereo Unbalanced to Mono Balanced



Features:

- Mix two unbalanced audio signals to mono balanced
- Combine stereo into mono with balanced output
- Unbalanced to balanced conversion without gain
- Hum cancellation on unbalanced line inputs
- Frequency response 30 Hz to 20 kHz (+/- 1 dB)



Passive, No Power Supply Required

Part # TX-J2

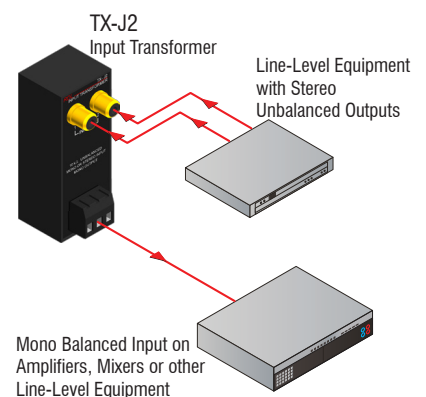

Questions?

RDL Tech Support: (928) 778-3554 | service@rdlnet.com

Product Applications & All Other Information:

www.rdlnet.com

Microphone Compressor

Increases Intelligibility of any Public Speaker

Microphone Products



Features:

- Provides Consistent Mic Levels Regardless of Speech Levels
- Prevents Distortion by Reducing Excessively-loud Mic Signals
- Improves Low-level Speech Intelligibility
- Prevents Distortion Prior to Mixer / Mic-preamp
- Compatible with Hard-wired or Wireless Microphones
- Installs Easily with 2 Screws or Optional RDL Mounting Accessories
- Ideal for Public Address Mics, Lectern Mics, Paging Mics, Portable Mics and Pass-around Mics



Power Supply Included:
PS-24AS (USA), PS-24AX (International)

Part # EZ-MCP1

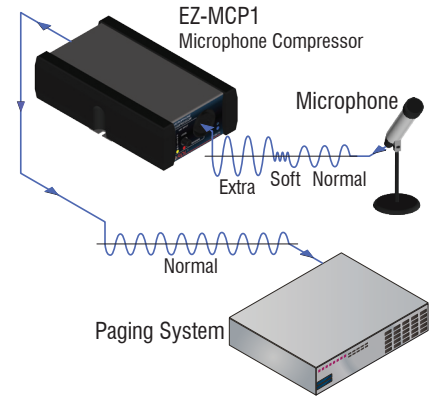

Adjustable Gain Microphone Preamplifier - 35 to 65 dB gain

Small, Mount-Anywhere Mic Preamp

Microphone Products



Features:

- Compact, Low-Noise Mic Preamp
- Adjustable Output Level
- High or Low Impedance Mic Inputs
- Mic Input to 2 Line Outputs
- Two Balanced or Unbalanced Outputs
- Phantom Capability
- RF-Filtered Inputs
- Versatility of STICK-ON® Compactness



Recommended Power Supply:
PS-24AS (USA), PS-24AX (International)

Part # STM-2

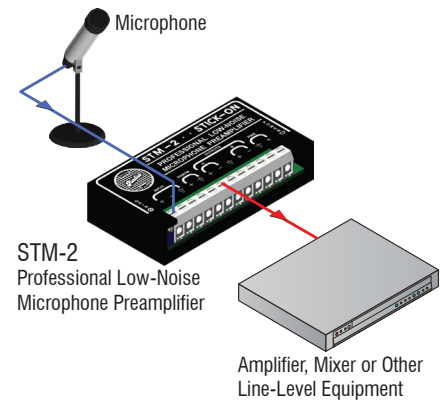

Studio Quality Microphone Preamplifier with phantom - 3 line outputs

Mic Preamp and Audio Distribution

Microphone Products



Features:

- Compact, Studio-Quality Microphone Preamplification
- Three Distributed Line-Level Audio Outputs
- Low-Noise and Low-Distortion Performance
- Selectable Filtered Phantom Voltage
- Adjustable Gain up to 60 dB
- RDL's® Exclusive Dual-LED VU Metering
- Versatility of STICK-ON® Compactness



Recommended Power Supply:
PS-24AS (USA), PS-24AX (International)

Part # STM-LDA3

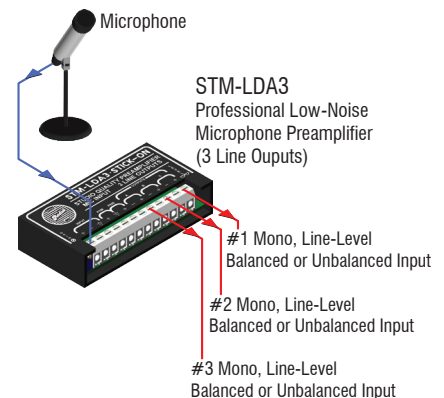

Microphone Phantom Adapter - 2 Channel

Phantom Power for 2 Mics

Microphone Products



Features:

- Add Phantom Powered Mics to Standard Inputs
- Two Phantom Adapters in one Module
- Phantom Conversion with Full Frequency Response
- Fully Adjustable Phantom Voltage
- Highly-Filtered Phantom Power
- Versatility of STICK-ON® Compactness



Recommended Power Supply:
PS-24AS (USA), PS-24AX (International)

Part # ST-MPA2

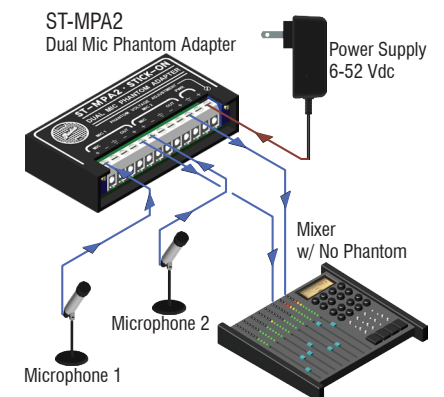

Questions?

RDL Tech Support: (928) 778-3554 | service@rdlnet.com

Product Applications & All Other Information:

www.rdlnet.com

Balanced to Unbalanced Converter - 2 channel

Convert Stereo Pro to Consumer Level



Features:

- Stereo Balanced to Unbalanced Audio Conversion
- Connectorized Audio Converter
- Output Level Trim
- Low-Noise and Low-Distortion Conversion
- Cabinet, Shelf or Rack Mounting
- Convenience of RDL® FLAT-PAKs™



Recommended Power Supply:
PS-24AS (USA), PS-24AX (International)

Part # FP-BUC2

Line Amplifiers / Interface

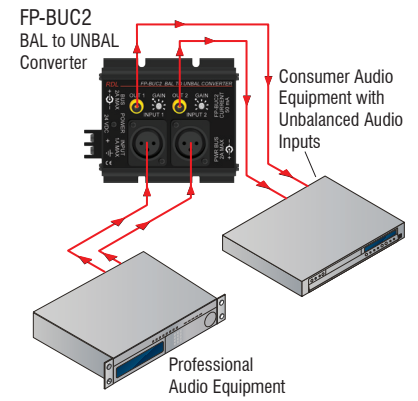

Unbalanced to Balanced Converter - 2 Channel

Convert Stereo Consumer to Pro Level

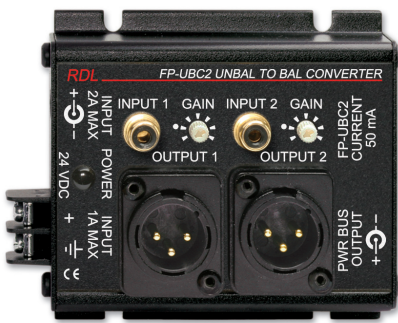

Features:

- Stereo Unbalanced to Balanced Audio Conversion
- Connectorized Audio Converter
- Output Level Trim
- Low-Noise and Low-Distortion Conversion
- Cabinet, Shelf or Rack Mounting
- Convenience of RDL FLAT-PAKS



Recommended Power Supply:
PS-24AS (USA), PS-24AX (International)

Part # FP-UBC2

Line Amplifiers / Interface

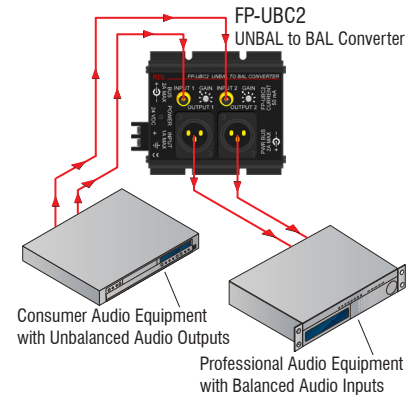

Dual High Gain Line Amplifiers

Boost 2 Line Level Signals

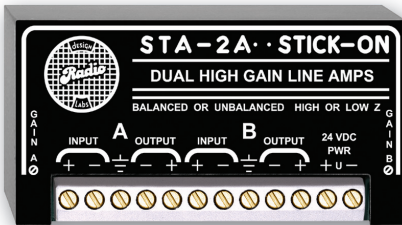

Features:

- Conversion between Unbalanced and Balanced Audio Signals
- Conversion between High and Low Impedance
- Up to 24 dB Gain in Audio Lines
- Low-Impedance, High-Current Line Drivers
- Dual-Channel Line-Level Preamplifiers
- High Gain, High Output, High Performance
- Versatility of STICK-ON® Compactness



Recommended Power Supply:
PS-24AS (USA), PS-24AX (International)

Part # STA-2A

Line Amplifiers / Interface

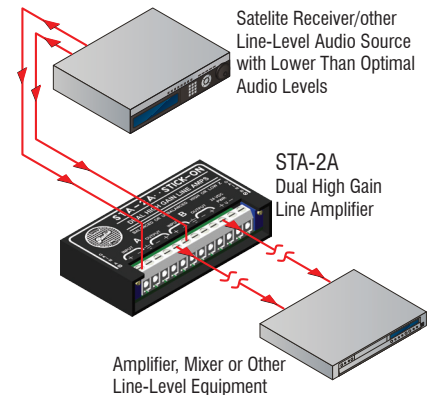

Unbalanced to Balanced Amplifier - 2 channel

Convert Stereo IHF Levels to Stereo PRO

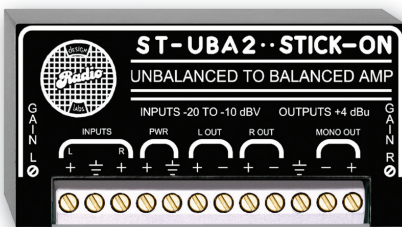

Features:

- Convert Stereo Consumer Audio Levels to Stereo PRO
- Additional Summed MONO OUT
- Independently Adjustable Gain
- Dual-LED VU Metering for Each Channel Included
- Unparalleled Audio Performance
- Versatility of STICK-ON® Compactness



Recommended Power Supply:
PS-24AS (USA), PS-24AX (International)

Part # ST-UBA2

Line Amplifiers / Interface

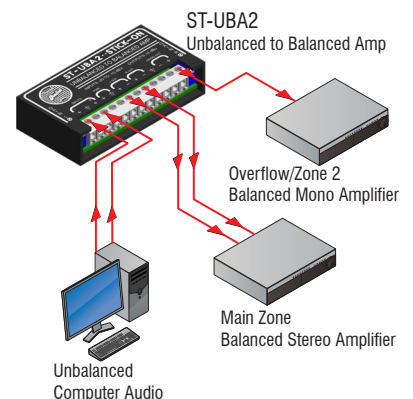

Questions?

RDL Tech Support: (928) 778-3554 | service@rdlnet.com

Product Applications & All Other Information:

www.rdlnet.com

Line-Level Audio Controlled Relay - 0.5 to 5 s

Switching & Control

Use Audio Presence to Switch Two Signals



Features:

- Switching Controlled by Audio Signal
- Sensing of Line-Level Signal
- Silence Sensing
- DPDT Switching Contacts
- Open-Collector SLAVE Output
- Release Delay Adjustable from 0.5 sec. to 5.0 sec.
- Versatility of STICK-ON® Compactness



Recommended Power Supply:
PS-24AS (USA), PS-24AX (International)

Part # ST-ACR1

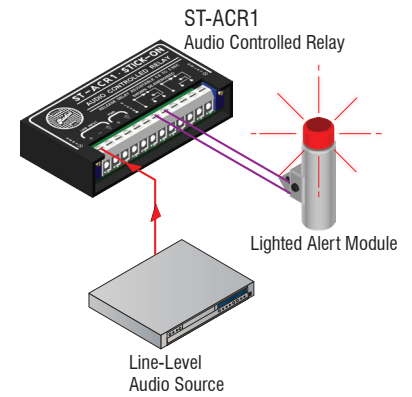

Line-Level Audio Controlled Relay - 5 to 50 s delay

Switching & Control

Use Audio Presence to Switch Two Signals



Features:

- Switching Controlled by Audio Signal
- Sensing of Line-Level Signal
- Silence Sensing
- DPDT Switching Contacts
- Open-Collector SLAVE Output
- Release Delay Adjustable from 5 sec. to 50 sec.
- Versatility of STICK-ON® Compactness



Recommended Power Supply:
PS-24AS (USA), PS-24AX (International)

Part # ST-ACR2

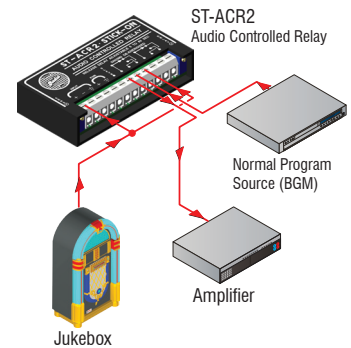

Line-Level Audio Switch - 2x1

Switching & Control

Fast Audio Switching From External Control

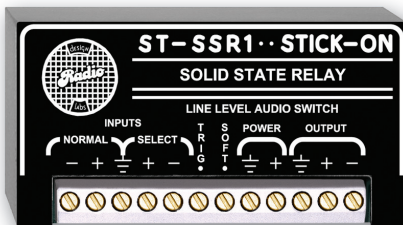

Features:

- Switch Line Level Sources
- Select Between Two Balanced Lines
- Silent Audio Switching
- Switching Without Hard Relay Contacts
- Fast Switching for Audio Muting
- Selection by Open-Collector Logic
- Versatility of STICK-ON® Compactness



Recommended Power Supply:
PS-24AS (USA), PS-24AX (International)

Part # ST-SSR1

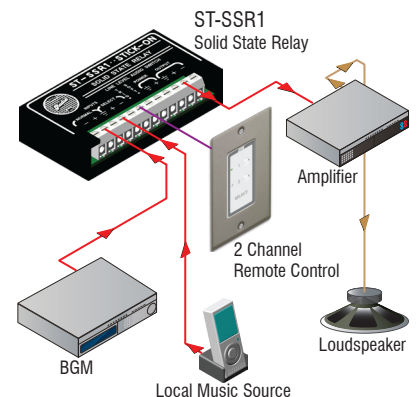

White and Pink Noise Generator

Signal Generators

Economical Noise Masking



Features:

- Designed for Continuous Use in Noise Masking Audio Systems
- Random Noise Source
- Masking Noise Sources
- Pink Noise
- White Noise
- Mic and/or Line Level Noise Signals
- Versatility of STICK-ON® Compactness



Recommended Power Supply:
PS-24AS (USA), PS-24AX (International)

Part # ST-NG1

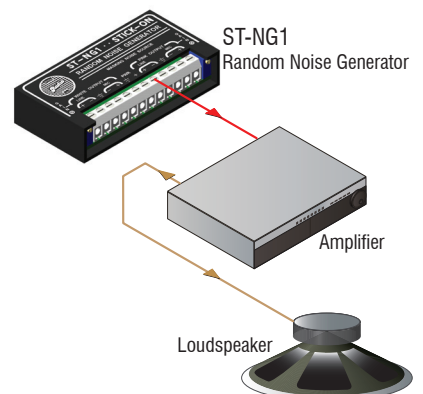

Questions?

RDL Tech Support: (928) 778-3554 | service@rdlnet.com

Product Applications & All Other Information:

www.rdlnet.com

18 W Mono Audio Amplifier - 8 Ohm

Power Amplifiers

Powerful Amplifier in a Small Package



Features:

- 18 Watts RMS Audio Power Amplifier
- Maximized Audio Level at Full Power Output
- Superior Audio Quality at High Output Levels
- Line Level Balanced or Unbalanced Input
- LOOP OUT to Feed Additional Amplifiers
- Integral Audio Compressor to Control Clipping
- High Overall Audio Operating Level
- LED to Indicate Audio Compression
- Versatility of STICK-ON® Compactness



Recommended Power Supply:
PS-24KS (USA), PS-24KX (International)

Part # ST-PA18

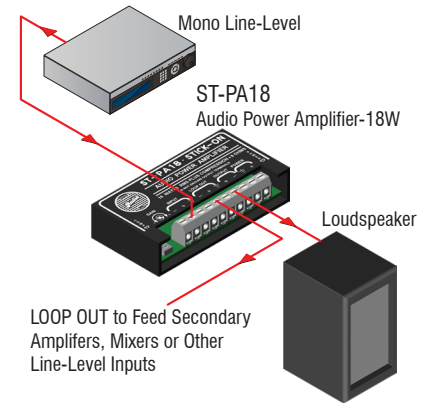

Compressor/Limiter - Line Level

Processing

Set-and-Forget Auto-Adjusting Audio Compressor



Features:

- Fully Automatic Positive Audio Level Protection
- Smooth Inaudible Gain Reduction
- Tight Audio Peak Control
- Very Low Noise Compressor
- Multi Stage Incremental Gain Reduction
- Superb Performance with Minimal Setup
- Versatility of STICK-ON® Compactness



Recommended Power Supply:
PS-24AS (USA), PS-24AX (International)

Part # ST-CL2

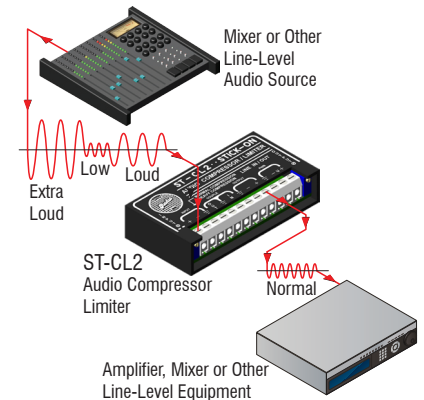

3 Band Equalizer - Line Level

Processing

Mount-Anywhere 3 Band Audio Equalizer



Features:

- 3-Band Audio Equalization
- Custom Tailored Audio Bandwidth
- Adjust To Pass Voice-Band Audio
- Adjust To Produce Smile-Curve for Music
- Low Noise and Low Distortion Equalization
- Versatility of STICK-ON® Compactness



Recommended Power Supply:
PS-24AS (USA), PS-24AX (International)

Part # ST-EQ3

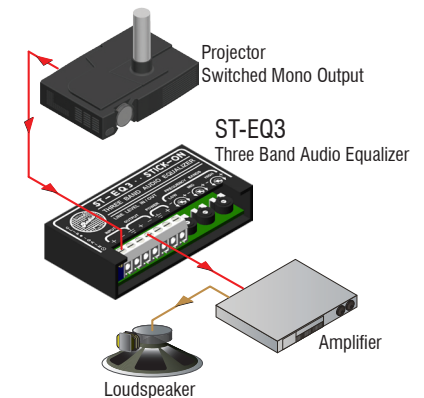

Gain Control Amplifier - Line Level

Processing

Boost Low Level And Reduce High Level Audio



Features:

- Automatic Audio Level Gain Control
- Wide Dynamic Range AGC
- Slow Inaudible Gain-Reduction
- Tight Dynamic Control
- Positive, Fast Gain Reduction
- Low-Noise and Low-Distortion AGC
- Versatility of STICK-ON® Compactness



Recommended Power Supply:
PS-24AS (USA), PS-24AX (International)

Part # ST-GCA3

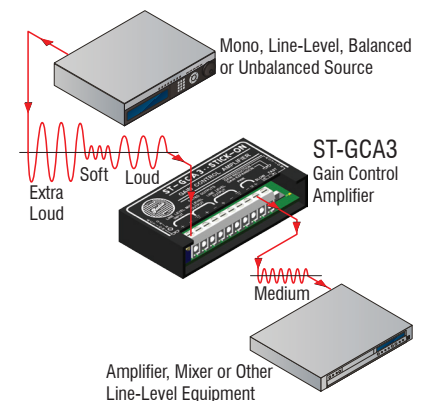

Questions?

RDL Tech Support: (928) 778-3554 | service@rdlnet.com

Product Applications & All Other Information:

www.rdlnet.com

Passive Audio Divider/Combiner - 10 kOhm

Mixing

Mix and/or Distribute Audio Signals

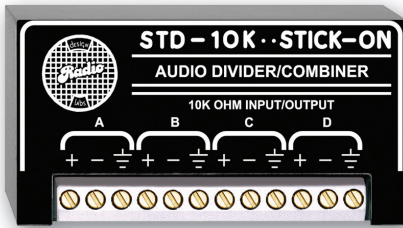

Features:

- Combine Audio Signals to a Single Output
- Combine Stereo Audio Signals
- Feed a Mono Signal to Stereo Inputs
- Combine Multiple Microphones to a Single Amplifier Input
- Filter RF from an Audio Line
- Versatility of STICK-ON® Compactness



Passive, No Power Supply Required

Part # STD-10K

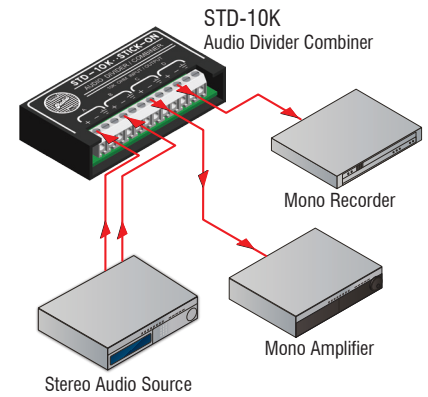

2 Channel Audio Mixer - Microphone or line input and output

Mixing

Ultra Compact 2 Channel Mic/Line Mixer



Features:

- Two Channel Audio Mixer
- Selectable Mic or Line Level Inputs
- Simultaneous Mic and Line Outputs
- Add Additional Inputs to an Existing Mixer
- Audio Output Dual-LED VU Metering
- Balanced or Unbalanced Inputs and Outputs
- Low-Noise and Low-Distortion Performance
- Versatility of STICK-ON® Compactness



Recommended Power Supply:
PS-24AS (USA), PS-24AX (International)

Part # ST-MX2

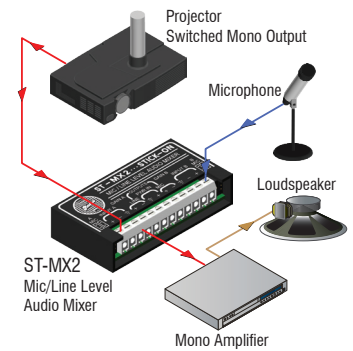

3 Channel Universal Audio Mixer - 3 microphone or line inputs x 1 microphone or line output

Mixing

Ultra Compact 3 Channel Mic/Line Mixer



Features:

- Audio Mixing with Up To Three Inputs
- Switch-Selectable Mic or Line Inputs
- Switch-Selectable Mic or Line Output
- Add Additional Microphone or Line Level Inputs to an Existing Mixer
- Combine Signals of Different Level, Impedance, or Balanced /Unbalanced Configuration
- Versatility of STICK-ON® Compactness



Recommended Power Supply:
PS-24AS (USA), PS-24AX (International)

Part # ST-UMX3

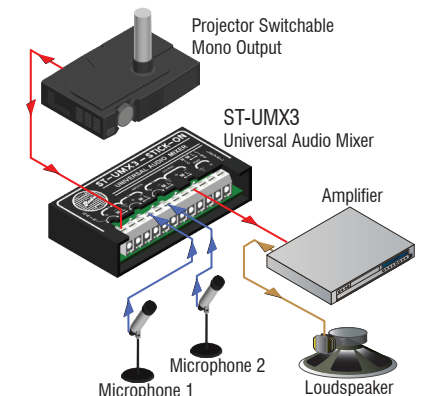

Line Level Distribution Amplifier - 1x3

Distribution

Convenient And Compact Audio Distribution



Features:

- Audio Distribution with up to 3 Outputs
- Balanced or Unbalanced Input and Outputs
- Bridge an Audio Line for Local Distribution
- Distribution with Impedance Conversion
- Distribution with Gain or Loss
- Inputs and Outputs RF-Protected
- 1x3 Mono or Use Two Units for Stereo



Recommended Power Supply:
PS-24AS (USA), PS-24AX (International)

Part # ST-DA3

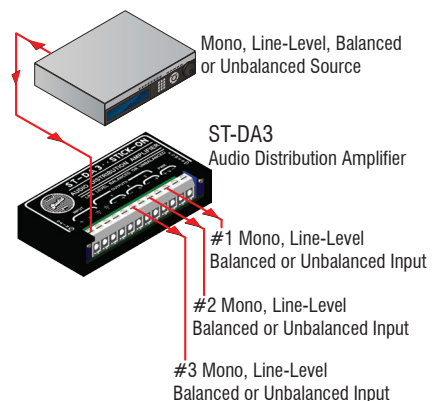

Questions?

RDL Tech Support: (928) 778-3554 | service@rdlnet.com

Product Applications & All Other Information:

www.rdlnet.com

Automatic Ducking Module

Voice Activated Audio Ducking

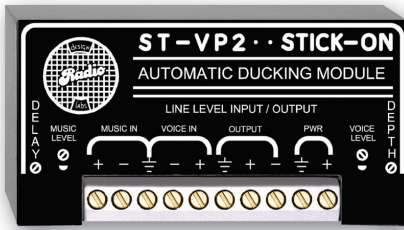

Features:

- Fully AUTOMATIC Voice-Over Mixing
- Noiseless Paging
- Adjustable Fade Depth
- Setting to Fade Music Fully Off
- Adjustable Recovery Rate
- Built-in AGC Compressor on Music Input
- Versatility of STICK-ON® Compactness



Recommended Power Supply:
PS-24AS (USA), PS-24AX (International)

Part # ST-VP2

Annunciation & Paging

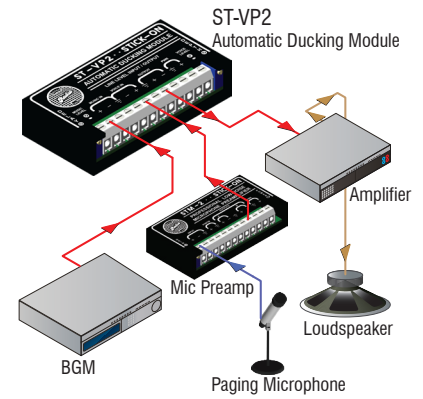

Paging Controlled Relay

Paging Signal Switches or Mutes Local PA

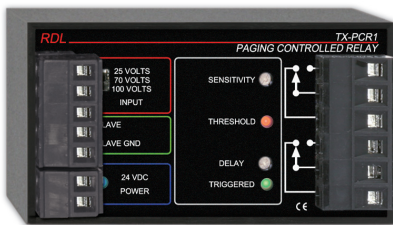

Features:

- Switching Functions Controlled by Speaker-Level Source
- Input Accepts Amplified Constant Voltage Signals
- Switch-Selectable Input: 25 V, 70 V, 100 V
- 25 Volt Input Also Accepts 8 Ohm Inputs up to 75 Watts
- Release Delay Adjustable from 3 to 25 Seconds
- Open-Collector Output Active when Module is Triggered
- Switches on Paging or Any Other Amplified Audio Signal
- 8 Amp DPDT Relay Contacts for Switching Speaker Loads
- Ideal for Muting or Switching Primary Speakers During Paging



Recommended Power Supply:
PS-24AS (USA), PS-24AX (International)

Part # TX-PCR1

Annunciation & Paging

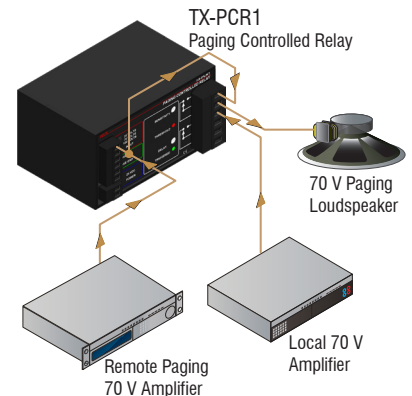

Paging Sound Detector

Paging Signal Mutes Local PA

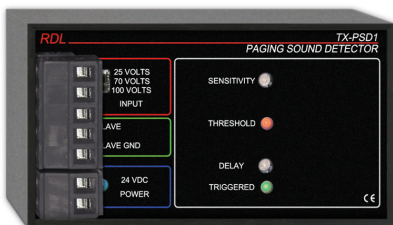

Features:

- Switching Functions Controlled by Speaker-Level Source
- Input Accepts Amplified Constant Voltage Signals
- Switch-Selectable Input: 25 V, 70 V, 100 V
- 25 Volt Input Also Accepts 8 Ohm Inputs up to 75 Watts
- Release Delay Adjustable from 3 to 25 Seconds
- Open-Collector Output Active when Module is Triggered
- Switches on Paging or Any Other Amplified Audio Signal



Recommended Power Supply:
PS-24AS (USA), PS-24AX (International)

Part # TX-PSD1

Annunciation & Paging

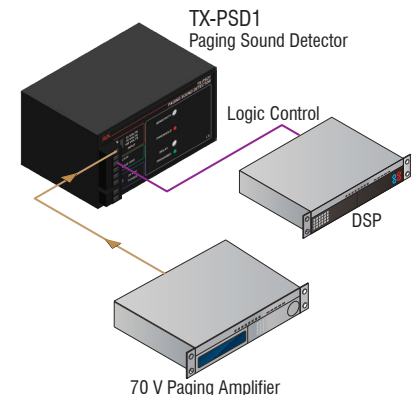

Voltage Controlled Amplifier

Add Remote Volume Control to any Amplifier

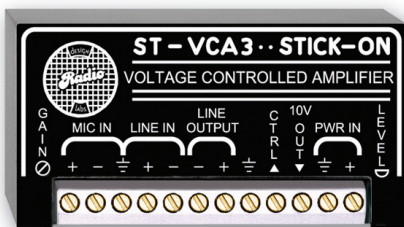

Features:

- Remote Control Amplifier Audio Levels
- Audio Level Control from a DC Voltage
- Audio Level Remote Control
- Two Wire with Shield or Three Wire Control
- VCA with Microphone or Line Level Input
- VCA with Line-Level Output
- VCA with LED Metering of Operating Level
- Versatility of STICK-ON® Compactness



Recommended Power Supply:
PS-24AS (USA), PS-24AX (International)

Part # ST-VCA3

VCA's & Related Products

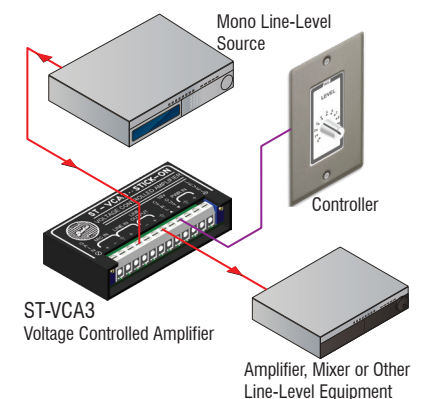

Questions?

RDL Tech Support: (928) 778-3554 | service@rdlnet.com

Product Applications & All Other Information:

www.rdlnet.com